

Pos. Nr. Pos.no.	Beschreibung Description	Art.-Nr. Art.no.	Preisgruppe Price bracket
72248	DB BR 18.4	=	
72249		=	🔊
78249		~	🔊
1	Kessel kpl. Betr.nr. 18 405 Boiler ass. compl. Loco no. 18 405	147878	34
2	TS-Kessel u. Umlauf Part set boiler a. runningboard	110651	10
3	TS-Pumpenhebel, FH-Streben Part set pump-lever	110673	9
4	Kesselleitungssatz Boiler line set	110674	9
5	Lokgewicht Loco weight	134568	8
6	TS-Gegenkurbel, Pfeife ... Part set	111219	6
7	Griffstange Führerhaus Handrail drivers cab	111221	3
8	Schaltstange rechts Switch rod right	111222	9
9	Tachogetriebe Tacho gear	111223	6
10	TS-Kessel u. Führerhaus Part set boiler a. drivers cab	111234	9
11	Aschkasten Ashpan	111235	8
12	TS - Kessel Part set boiler	111238	11
13	Seutheisolierung Seuthe insulating	111239	3
14	TS-Kesselleitung Schmierpumpen Part set boiler line, lube pump	111241	9
15	TS-Stirbleiter u. Pumpen Part set front ladder a. pump	111242	6
16	Kesselleitung links Boiler line left	111245	3
17	Griffstangensatz Handrail set	111247	9
18	Leitungssatz Line set	111248	6
19	Sanddomstange Sand dome rod	111293	5
20	Pumpenhebel lang Pump lever long	111533	3
21	GF-Schraube M2x6 mm GF-Screw	114828	3
22	Führerstandsboden Drivers cab bottom	117112	9
23	Pumpensteckteil Pump part	117122	3
24	Umlaufblechsatz Part set running board	117123	18
25	Griffstange Führerhaus Handrail drivers cab	117130	4
26	TS-Lichtleiter u. Fenster Part set light transmission bar a. window	110637	12
27	Führerhaus kpl. Drivers cab	147879	18
28	TS - Kessel Part set boiler	110653	11
29	Kesselboden Boiler bottom	147882	8
Sound			
30	GF-Schraube M1,6x4 mm GF-Screw	114850	3
31	Lautsprecherplatine Printed circuit ass. for loudspeaker	128481	10
32	Lautsprecher Loudspeaker	129524	13

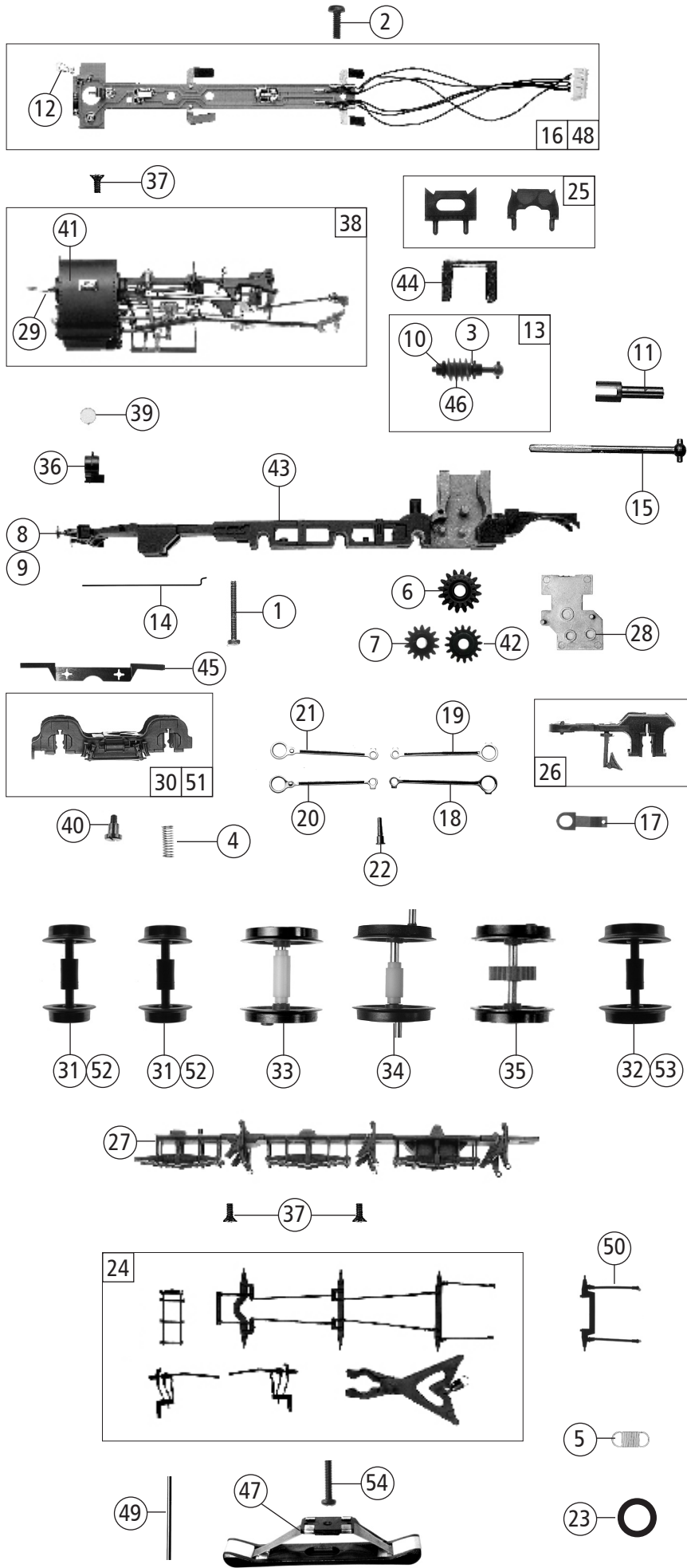

Pos. Nr. Pos.no.	Beschreibung Description	Art.-Nr. Art.no.	Preisgruppe Price bracket
72248	DB BR 18.4	=	
72249		=	🔊
78249		~	🔊
1	Schraube M2x18 mm Screw	85679	4
2	Schraube M1,6x4 mm Screw	114850	3
3	Beilagscheibe Washer	86108	3
4	Druckfeder Pressure spring	86201	3
5	Zugfeder Spring	86208	3
6	Schnecken Zahnrad Worm gear	86419	6
7	Zwischenzahnrad Gear	86480	3
8	Puffer flach Metall Buffer flat	88521	6
9	Puffer gewölbt Metall Buffer vaulted	88522	6
10	Lager für Schneckenachse Bearing for worm axle	89749	6
11	Kardanschale lang Cardan bearing long	109248	5
12	Drahtlampe 16V Light bulb 16V	109321	8
13	Schneckensatz Worm set	110656	13
14	Tachowelle Tacho shaft	110663	4
15	Kardanwelle Cardan shaft	110665	5
16	Lokplatine kpl. Loco printed circuit	110875	24
17	Nachlaufgestellfeder Bogie spring	110893	4
18	Kuppelstange bedruckt 1 rechts Connecting rod printed 1 right	111214	7
19	Kuppelstange bedruckt 1 links Connecting rod printed 1 left	111215	7
20	Kuppelstange bedruckt 2 rechts Connecting rod printed 2 right	111216	7
21	Kuppelstange bedruckt 2 links Connecting rod printed 2 left	111217	7
22	Bolzen Pin	111218	3
23	Scheibe Washer	111220	3
24	Teilesatz Part set	111224	10
25	Kesselstützensatz Boiler holder set	111233	6
26	Nachlaufgestell ohne Radsatz Bogie without wheelset	111246	8
27	Lokboden Loco bottom	111250	12
28	Lokgetriebedeckel Loco gear cover	111251	12
29	Kolbenschutzrohr Piston protective conduit	111253	3
30	Vorlaufgestell ohne Radsatz Pilot frame without wheelset	111254	10
31	Vorlauf radsatz Pilot wheelset	111255	9
32	Nachlauf radsatz Wheelset	111256	9
33	Radsatz 1 Wheelset 1	111257	12
34	Radsatz 2 Wheelset 2	111258	12
35	Radsatz 3 Wheelset 3	111259	12
36	Loklaterne Ep 2 Loco lantern Ep2	111260	3
37	SK-Schraube M2x4 mm SK-Screw	115541	3
38	Steuerung kpl. Steering ass.	147883	36
39	Linse klein Lens small	117118	3
40	FK-Schraube FK-Screw	117120	3
41	Zylinderblock Cylinderblock	147884	14
42	Zahnrad Z=16 Gear Z=16	117617	3
43	Lokgrundrahmen bedruckt Loco frame printed	147877	16
44	Schneckendeckel Worm Cover	94707	4
45	Vorlauf radkontakt Pilot wheel contact	112324	3
46	Schnecke Worm gear	86704	6
AC - Wechselstrom			
47	Schleifer Slider	86033	14
48	Lokplatine AC Loco printed circuit AC	110881	24
49	Kontaktstift AC Contact pin	110708	4
50	Bremsgestänge Brake linkage	111263	7
51	Vorlaufgestell Pilot frame	111264	10
52	Vorlauf radsatz Pilot wheelset	111265	9
53	Nachlauf radsatz Wheelset	111266	9
54	GF-Schraube M1,6x6 mm GF-Screw	114836	3

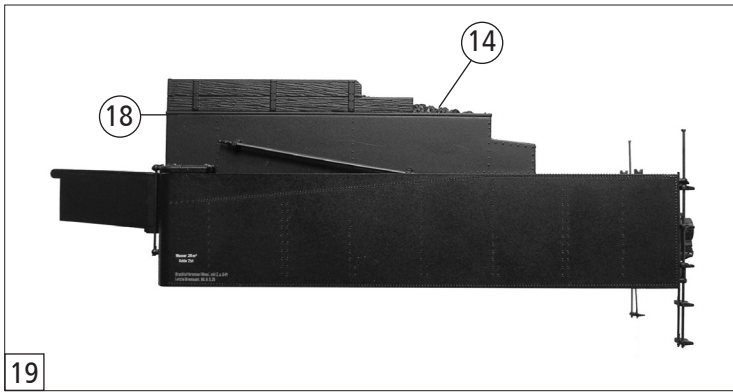

19

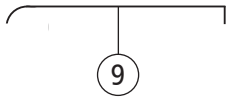

9

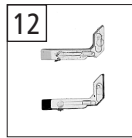

12

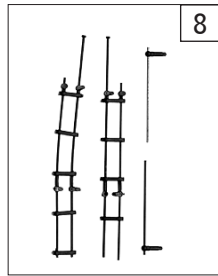

8

10

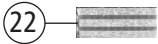

22

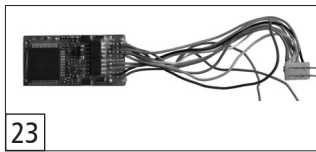

23

2

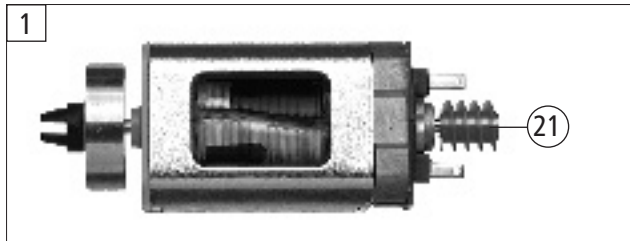

1

21

5



11 24

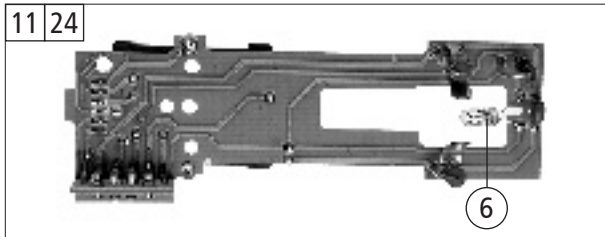

6

15



16



7

20

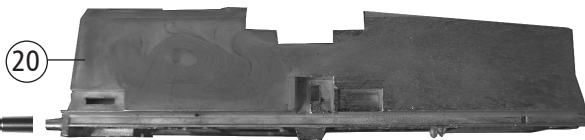

3

4



17



17



13

Pos. Nr. Pos.no.	Beschreibung Description	Art.-Nr. Art.no.	Preisgruppe Price bracket
72248	DB BR 18.4	=	
72249		=	🔊
78249		~	🔊
1	Motor Motor	85132	28
2	Kardanschale Cardan bearing	87129	4
3	Puffer flach Metall Buffer flat	88521	6
4	Puffer gewölbt Metall Buffer vaulted	88522	6
5	Brückenstecker Connector	100644	6
6	Drahtlampe 16V Light bulb 16V	109321	8
7	Motorspannblock Engine block	110633	3
8	TS-Tender Part set tender	110639	9
9	Tendertürfeder Tender door spring	110640	4
10	Drahtstift Pin	110641	4
11	Tenderplatine kpl. Tender printed circuit ass.	110669	25
12	Tenderlichtleitersatz Tender light transmissionbar ser	110672	6
13	Druckfeder Pressure spring	110690	4
14	Kohleeinsatz Coal insert	110691	6
15	Platinenniederhalter Printed circuit holder	111227	4
16	GF-Schraube M1,6x8 mm GF-Screw	115037	3
17	GF-Schraube M1,6x10 mm GF-Screw	114881	3
18	Tenderoberteil Tender upper part	117126	10
19	Tendergehäuse lackiert Tender body coated	147870	20
20	Tendergrundrahmen Tender base frame	147872	16
21	Schnecke Wormgear	86704	6
Sound			
22	Lötverbindung Solder joint	131427	5
23	Sounddecoder Sounddecoder	129600	39
AC - Wechselstrom			
24	Tenderplatine AC Tender printed circuit AC	110705	25

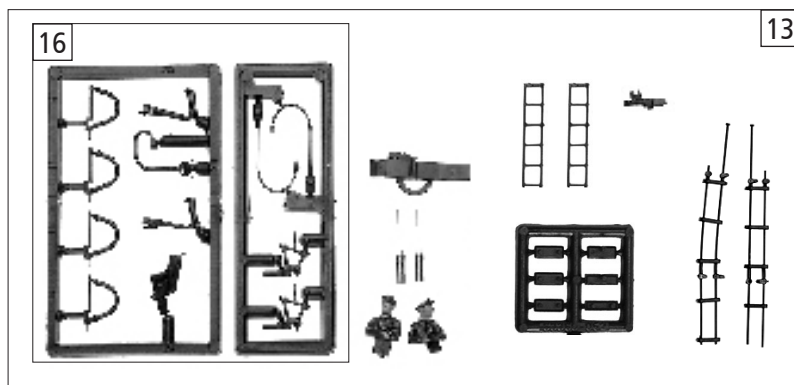
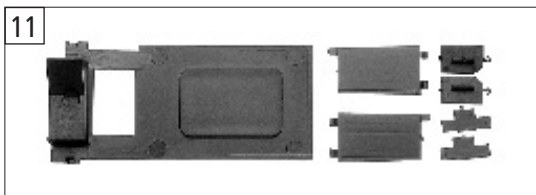
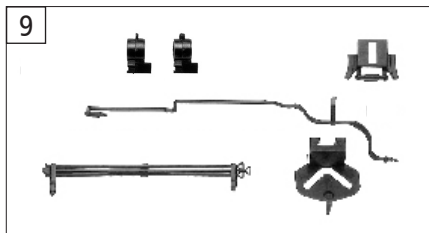
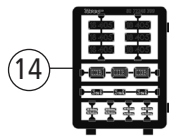
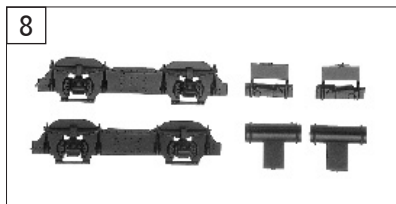
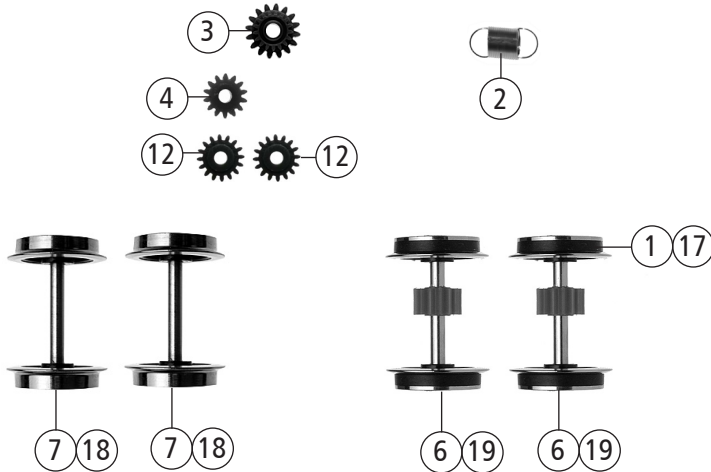
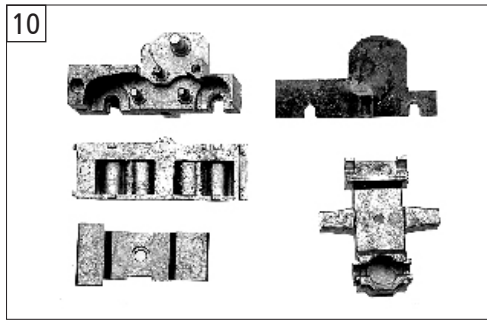

Pos. Nr. Pos.no.	Beschreibung Description	Art.-Nr. Art.no.	Preisgruppe Price bracket
1	Haftringsatz 10Stk. 10,3-12,8mm Set w. traction tiers 10 pieces 10,3-12,8mm	40069	---
2	Zugfeder Draw spring	86208	3
3	Schneckenzahnrad doppelt Worm gear double	86419	6
4	Zwischenzahnrad Gear	86480	3
5	Attrappenrahmen Push in part set	107808	4
6	Radsatz m. Haftringen m. Zahnrad Wheelset w. traction tiers w. gear	111228	12
7	Radsatz o. Haftringen o. Zahnrad Wheelset without traction tiers without gear	111229	9
8	TS-Tender Part set tender	111230	12
9	TS-Kessel u. Tender Part set boiler a. tender	111231	12
10	Getriebesatz Tender 5-teilig Gear set tender 5-parts	111232	15
11	Teilesatz Part set	111244	10
12	Zahnrad Z=16 schwarz Gear Z=16 black	117617	3
13	Zurüstbeutel Bag w. accessories	147894	13
14	Tafelsatz Set of panels	147897	12
15	Standardkupplung Schwalbenschwanz Standard coupling	89278	6
16	Zubehörrahmensatz Set of accessory frames	108322	7
AC - Wechselstrom			
17	Haftringsatz 10Stk. 10,3-12,4mm Set w. traction tiers 10 pieces 10,3-12,4mm	40074	---
18	Radsatz o. Haftringen o. Zahnrad Wheelset without traction tiers without gear	108304	10
19	Radsatz m. Haftringen m. Zahnrad Wheelset w. traction tiers w. gear	111262	12